

**Notes:**  
 Minimum Wall Thickness 4.75mm

Category: **FIXED HEIGHT SQUARE CHAMBER SYSTEMS**

Product Description: **1m square base chamber with a fixed corbel and square 760mm raised cover. 1m tank flange detail**

For reference purposes only.  
 This drawing is not a specification.

Drawing No: **22001**

Product Code **S5-210**

Date: **Jan 2000**

Revisions: **0**

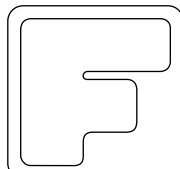

**FIBRELITE**

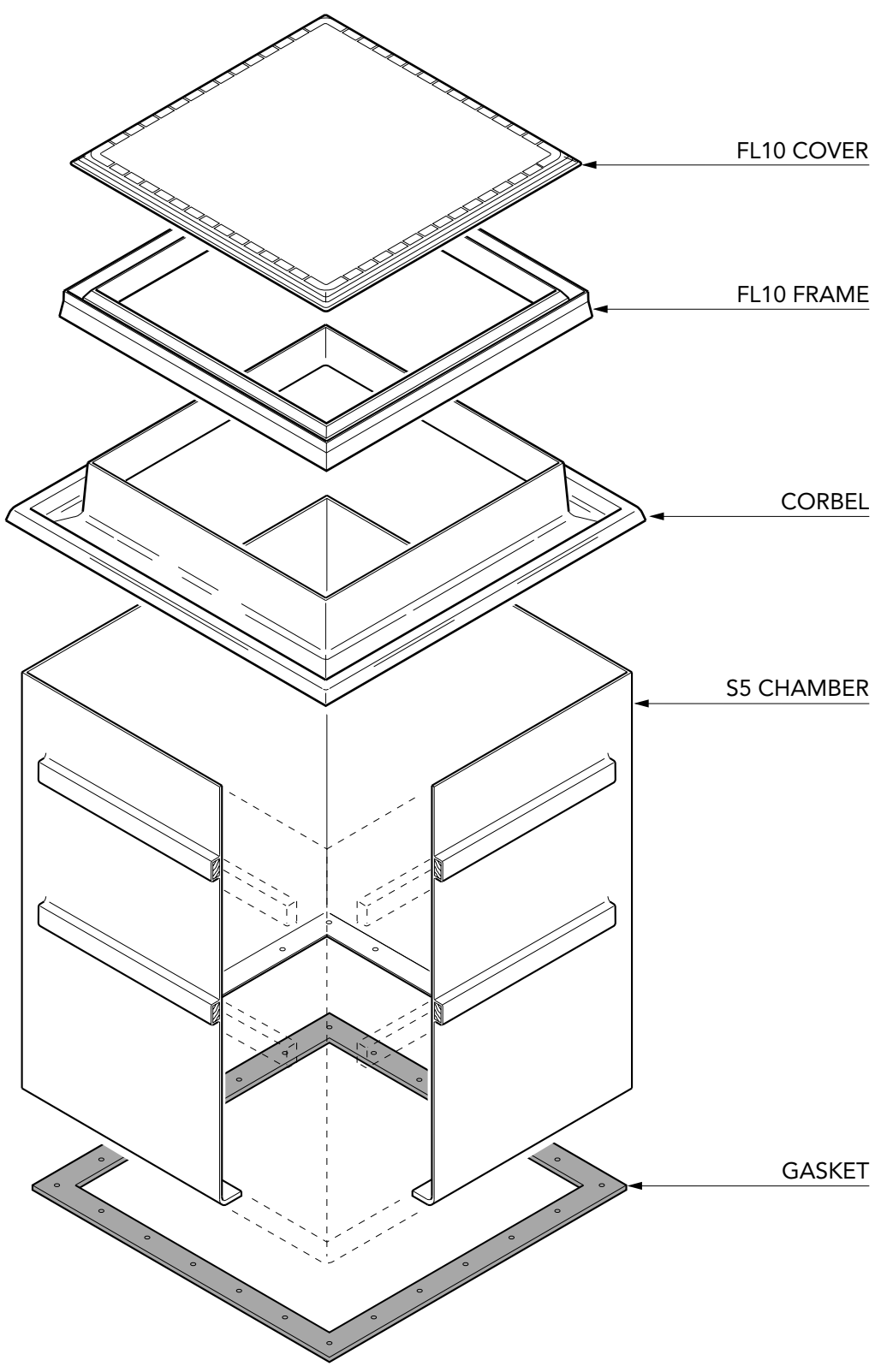

**Notes:**  
 Minimum Wall Thickness 4.75mm

Category: **FIXED HEIGHT SQUARE CHAMBER SYSTEMS**

Product Description: **1m square base chamber with a fixed corbel and square 760mm raised cover. 1m tank flange detail**

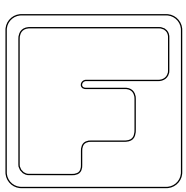

For reference purposes only.  
 This drawing is not a specification.

Drawing No: **22110**

Date: **Jan 2000**

Product Code **S5-210**

Revisions: **0**

**FIBRELITE**



**VERY IMPORTANT**  
 OUTER EDGE "A" OF FRAME SET 5 - 10MM  
 ABOVE GENERAL FORECOURT AREA WITH  
 CONCRETE RAMPED AWAY OVER 300MM.

**TYPICAL INSTALLATION**

**CONCRETE**

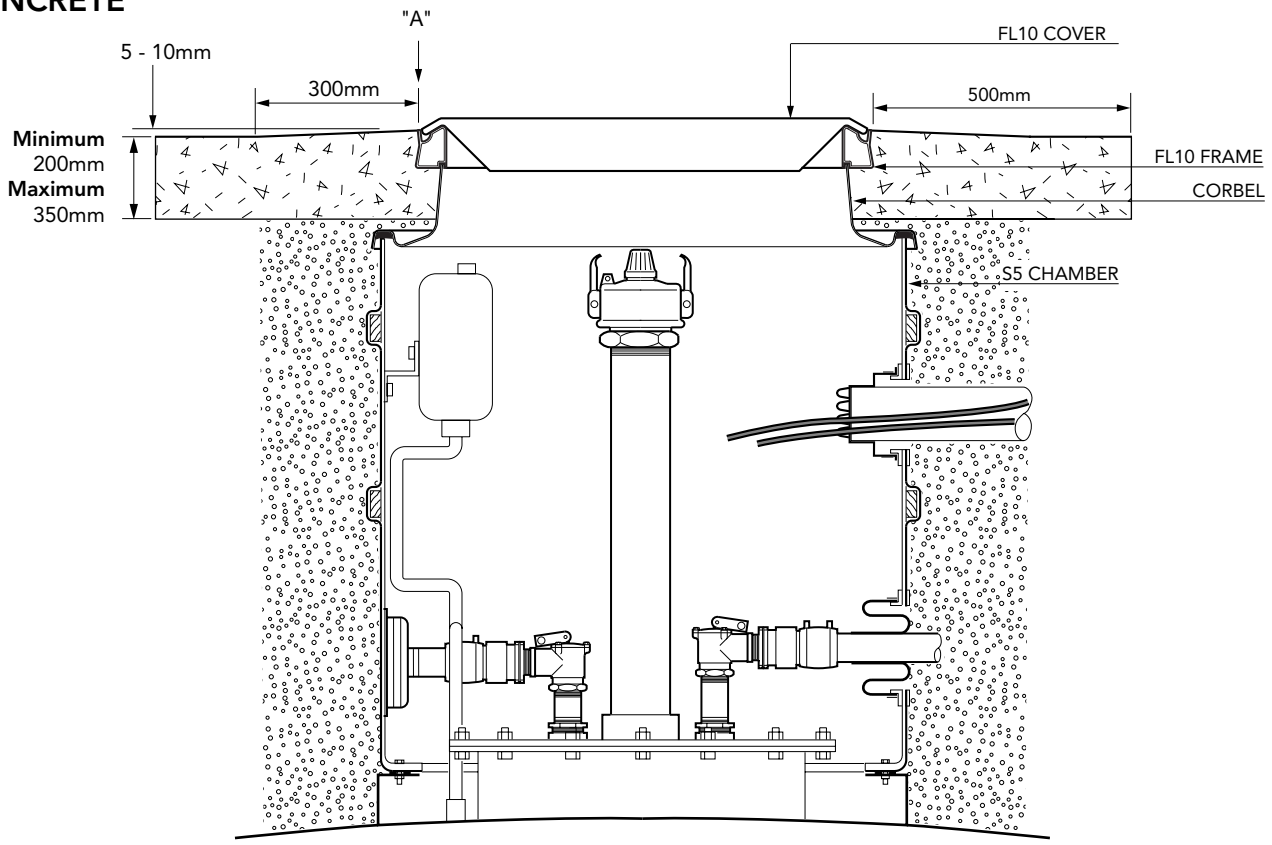

**ALTERNATIVE INSTALLATION ADVICE**

**TARMACADAM**

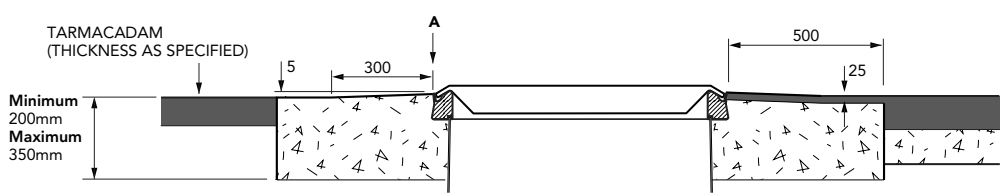

**SETTS**

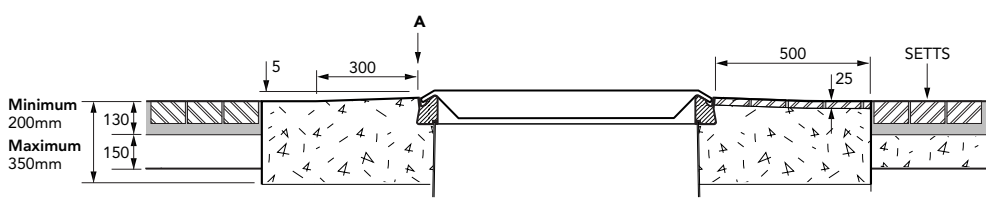

**Notes:**  
 Minimum Wall Thickness 4.75mm

Category: **FIXED HEIGHT SQUARE CHAMBER SYSTEMS**

Product Description: **1m square base chamber with a fixed corbel and square 760mm raised cover. 1m tank flange detail**

For reference purposes only.  
 This drawing is not a specification.

Drawing No: **22111**

Product Code **S5-210**

Date: **Jan 2000**

Revisions: **0**

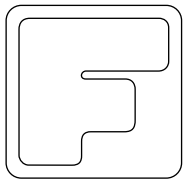

**FIBRELITE**

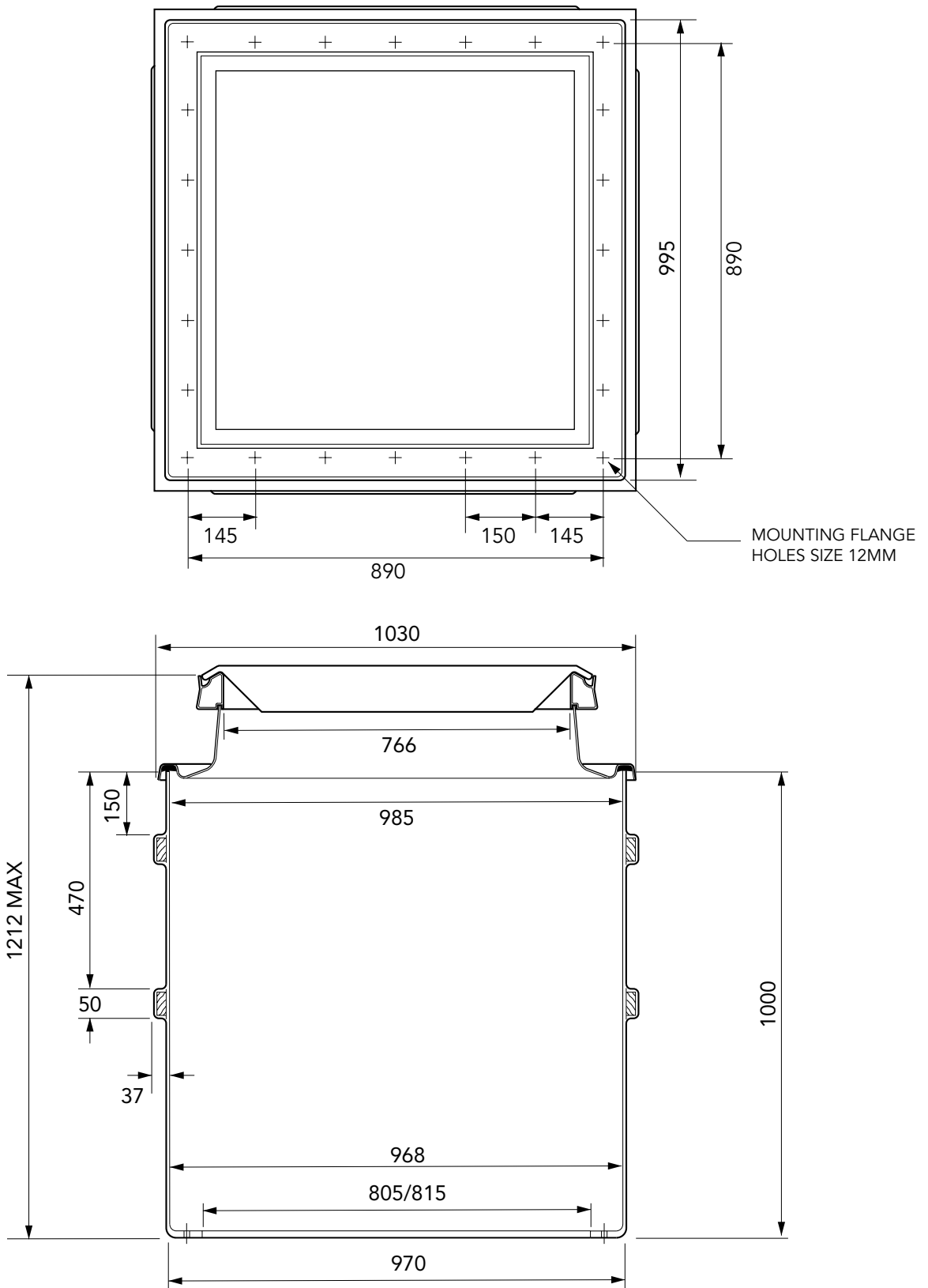

**Notes:**  
 Minimum Wall Thickness 4.75mm

Category: **FIXED HEIGHT SQUARE CHAMBER SYSTEMS**

Product Description: **1m square base chamber with a fixed corbel and square 760mm raised cover. 1m tank flange detail**

For reference purposes only.  
 This drawing is not a specification.

Drawing No: **22112**

Product Code **S5-210**

Date: **Jan 2000**

Revisions: **0**

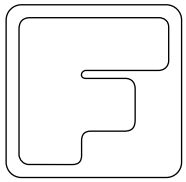

**FIBRELITE**