

# CTS Multi-Zone Alarm V3

## Mains Powered



Codes: SWS2000 / SWS2001



# INDEX

---

PAGE	SECTION
2	INDEX
3	SAFETY WARNINGS
4-5	INSTALLATION
6	PRELIMINARY CHECKS
7	ALARM OPERATION
8	CABLE ENTRY, PROBE CONNECTIONS
9	RELAY OUTPUTS, DISPLAY BOARD DIAGRAM
10	POWER BOARD DIAGRAM
11	EXTENDED CONFIGURATION
12	TECHNICAL SPECIFICATIONS

---

# SAFETY WARNINGS



**WARNING:** Electricity can kill!

**Before** connecting the alarm  
**always** disconnect the supply at the consumer unit.  
If in **any** doubt consult a qualified electrician.

PLEASE USE TOOLS WITH PRECAUTION.  
MISUSE OF HAND/POWER TOOLS  
CAN CAUSE SERIOUS HARM!

# INSTALLATION



**WARNING: Electricity can kill!**

**Before** connecting the alarm **always** disconnect the supply at the consumer unit. If in **any** doubt consult a qualified electrician.

This unit is designed for installation in exposed locations. **DO NOT** damage the front panel seal, failure to do so could result in water ingress.

1. Open the Perspex door by turning the white tab anticlockwise a quarter turn. Remove this door from the unit.

2. Remove the front panel by turning the four plastic screws anticlockwise half a turn.



3. Once all four plastic screws are vertical, proceed to lift the front panel from the base. **(DO NOT ALLOW THE FRONT PANEL TO HANG UNSUPPORTED ON THE RIBBON CABLES)**

4. Drill out the four mounting holes in the base.

5. Cable entry glands are to be positioned at the bottom.

6. Screw the base to the mounting surface ensuring the sealing caps are inserted to prevent water ingress. **(THE BASE MUST BE FLAT. DISTORTION CAN RESULT IN WATER INGRESS)**

7. Use four non-countersunk screws for mounting, do not overtighten.



8. Feed the probe cable through the gland and connect to the probe screw terminal. Repeat the step for the second and third probes.

Typical system setting:

**Zone 1** - Overfill / High probe

**Zone 2** - Bund Probe

**Zone 3** - Low Level Probe

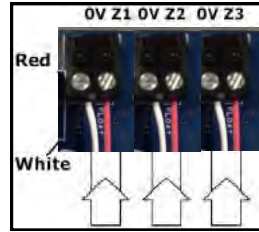

9. The power supply must be isolated.

Connect the power cable and select the voltage switch.

The unit is manufactured with a supply voltage of either 230v AC, 115v AC, 24v DC or 12v DC.

**Never connect both AC and DC power simultaneously to the power supply as this will damage the unit.**

If in any doubt consult a qualified electrician.

**Power Input - AC 230v or 115v**



10. Reconnect the front panel door ensuring the ribbon cable is connected and the seals are undamaged.

### Power Input - DC 12v or 24v

The DC supply, Brown wire should go to positive (B+) and Blue to negative (B-).

**It is important to take basic safety precautions and ensure the power is off during wiring.**



**12v DC or  
24v DC Input**

# PRELIMINARY CHECKS

## POWER

The power LED should be illuminated. Press the **TEST** button for 2 seconds to make sure the alarm is operational. If no zones are active, the lights and sounder will stop when the button is released.

## PROBES

Before installing the probes into the tank, manually move the float by hand. The **HIGH** and **BUND** alarms will sound when the floats are moved to the top of the shaft and the corresponding LED should illuminate.

The LOW level alarm will sound when the float is moved to the bottom of the shaft.

If the **HIGH** or **BUND** alarms sound when the float is moved to the bottom of the shaft or the **LOW** level float moves to the top of the shaft, then remove the float by taking off the cir-clip, rotating the float 180°, refitting to the shaft and putting the cir-clip back to where it was removed from. (See diagram)

The probe position can be adjusted to the required height by loosening the cable gland on the brass cap. The cap can then be moved up or down the cable until the required height is achieved. Retighten the cable gland and secure the cap to the tank.

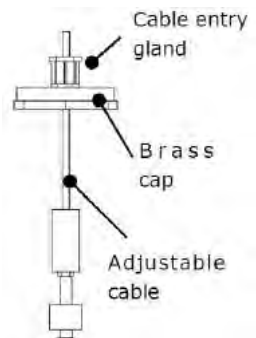
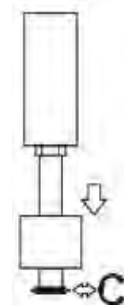

# ALARM OPERATION

To test the alarm press and hold the **TEST** button. Whilst the button is pressed, all the configured zones, fault, strobe and sounder will activate. If no zones are active, all the lights and sounder will stop when the button is released.

To mute an active alarm, press the **MUTE** button. The strobe & sounder will stop but the active zone LED will remain illuminated until the zone is cleared.

The 3 displays can be configured as any of the following:

**High - H**      **Bund - b**      or      **Low Level - L**

Alarm configuration is displayed when the **TEST** button is pressed & held.

Periodically - and **specifically before each filling** - to ensure unit has power and is operating correctly press and hold the **TEST** button, all zones and the amber strobe should illuminate and the sounder should activate.

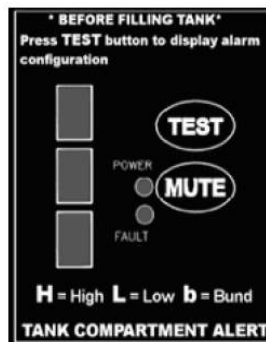

**To change the display, adjust the Zone Jumpers Z1, Z2 & Z3:**

**H** on Display = Jumper set to **HIGH**

**L** on Display = Jumper set to **LOW**

**b** on display = Jumper set to **BUND**

**No Display** = Jumper set to **OFF - Zone De-activated**

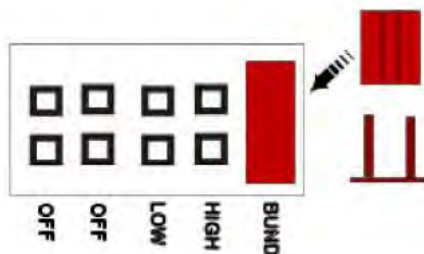

# INSTALLATION DIAGRAMS

## CABLE ENTRY

If the cable entry point is not used, remove gland and seal hole with the blanking cap supplied.

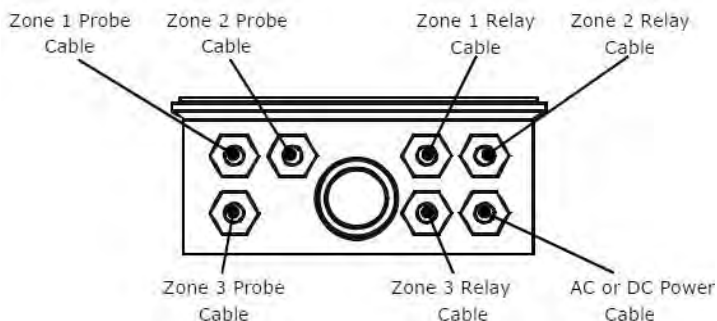

## PROBE CONNECTIONS

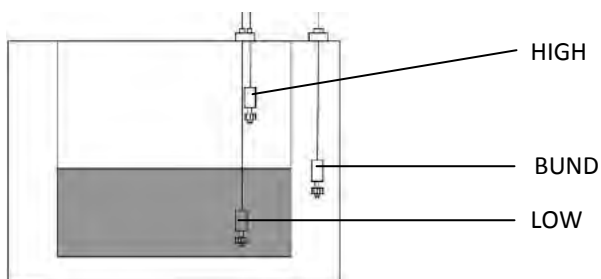

The probe wired to the **HIGH** connection is positioned at the topmost part of the tank and is used to alert that an overfill has occurred. The probe wired to the **LOW** connection should be positioned near the bottom of the tank to indicate a low-level. The **BUND** probe is placed between the two tank 'skins' and is used to quickly alert of any leaks.

When shipping a tank by road, make sure the probes are stored at the top of the tank to prevent any damage cause from swinging.



## RELAY OUTPUTS (OPTIONAL)

The volt free relay outputs allow switching of external equipment when either High, Bund or Low-level zones are activated e.g. an external sounder can be activated in the event of an overflow.

Printed on the boards are:

C = Common

N/O = Normally Open

N/C = Normally Closed

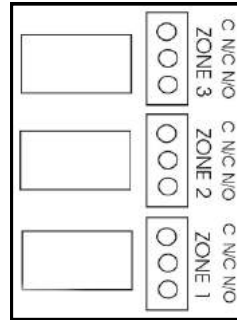

Maximum switch voltage is 240v and maximum switch current is 8 Amps.

## INTERNAL LAYOUT DIAGRAM (DISPLAY BOARD)

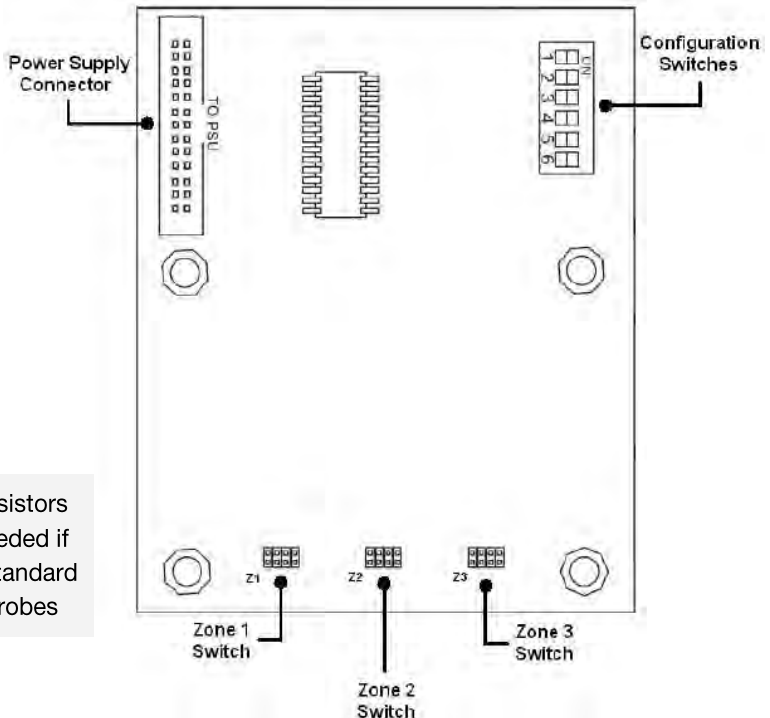



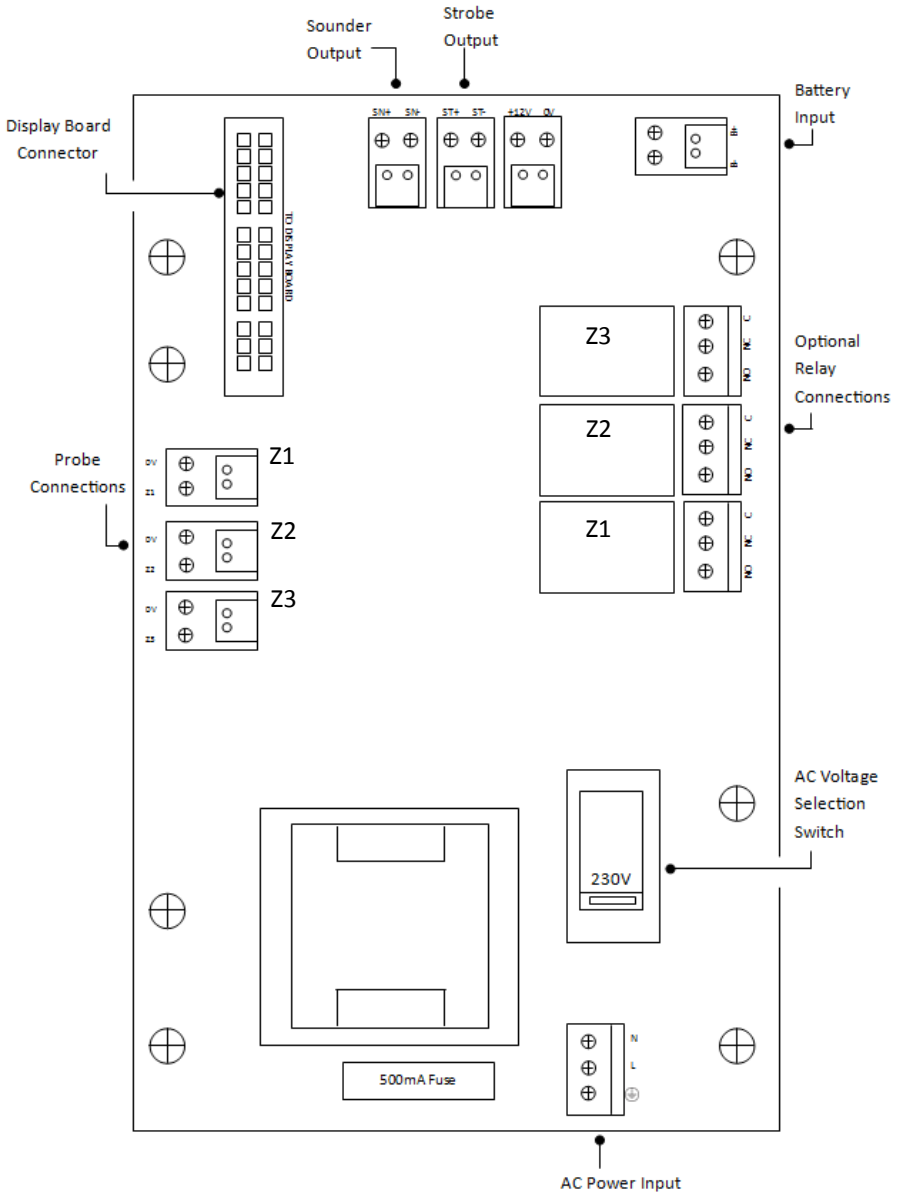

Included resistors are only needed if using non-standard resistive probes

# POWER BOARD DIAGRAM

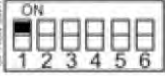

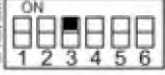
# EXTENDED CONFIGURATION

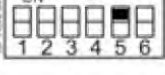
Switch No	Status	Function	Example
1	OFF	Standard Switched BUNA probes	
1	ON	Resistive Type Probes 1-2KΩ (2K resistors required on non used zones)	
2	OFF	Normal	
2	ON	Sounder OFF on Zone-1 & Zone-3 If SW2 = ON then SW3 must be OFF	
3	OFF	Normal	
3	ON	Sounder OFF on Zone-3 only If SW3 = ON then SW2 must be OFF	
4	OFF	Normal	
4	ON	Pump Controller on Zone-1 & Zone-3  Set Zone-3 to LOW Set Zone-1 to HIGH Connect Pump switching through ZONE-3 Relay  When Zone-3 (LOW) is activated, Zone-3 relay will stay switched on until Zone-1 (HIGH) is activated – system will automatically reset ready for Zone-3 (LOW) activation again.  N.B. Wire in a separate EMERGENCY stop button into pump circuit.	
5	OFF	Normal	
5	ON	Single Tank Mode (Fault Testing)  If Zone-1 (HIGH) and Zone-3 (LOW) activate together then fault condition occurs - (single tank mode only).	
6	OFF	N/A	
6	ON	N/A	

Normal Condition:

Whenever a zone is activated, the seven segment display of the active zone will display the status, 'H', 'B', 'L'. The strobe will activate and the relay for the active zone will switch.

Pressing 'MUTE' will turn off the strobe and sounder, the display and relay will only

# TECHNICAL SPECIFICATIONS

Supply voltage (A.C.)	230v / 115v, 50 Hz-60Hz, 1.0A
Supply Voltage (D.C.)	DC 12-24v, 1.0A
Installation environment	Pollution Degree 3, Installation Cat II
Operating Temperature	-20°C to +50°C
Ambient Temperature Storage	-30°C to +60°C
Maximum Altitude	2000 Meters
Humidity (Operating)	5 to 100% RH, Non-condensing
<b>Enclosure</b>	
Dimensions (L x H x D)	145 x 242 x 110 (mm)
Colour	Light Grey RAL 7035
IP Rating	IP 55
Material	Polycarbonate
<b>Sounder</b>	
Frequency	2600 Hz
Sound Output @12v	90 dB
<b>Float</b>	
Material	Nylon Stem, NBR Float, PVC Cable, S/S Clip
Specific Gravity	0.70
Cap Mounting Thread	1.5" BSP
Cable Length	5 meters



**Tel:** +44 (0)121 351 4445 **Fax:** +44 (0)121 351 4442  
**Email:** sales@centretank.com **Web:** www.centretank.com

Company registered in England 2136427, VAT: 478203830, WEEE: WEE/CH0630XY

